

## DS-2DE5220IW-AE

### Value Series 2 MP 20x IR Outdoor Network Speed Dome

- 1/2.8" Progressive Scan CMOS
- Up to 2048 x 1536 Resolution
- 30x Optical Zoom, 16x Digital Zoom
- IR Distance up to 492 ft (150 m)
- Digital WDR
- 3D Intelligent Positioning Function
- Support for H.265+ / H.265 Video Compression
- IP66, IK10
- 24 VAC / Hi-PoE (injector supplied), 32 W



The Hikvision DS-2DE5220IW-AE Value Series Network Speed Dome Cameras are designed for demanding applications and feature IP66 and IK10 ratings.

DS-2DE5220IW-AE cameras also feature a wide range of Smart functions, including intrusion detection, line crossing detection, and audio exception, benefitting users with great improvements on security efficiency and, more importantly, with key events and objects being

recorded for further forensic needs. Also featured is Smart Tracking, which enables a camera to detect any progressively moving object and follow it within the camera's area of coverage. Defog is also supported to improve image quality in challenging conditions.

**Available models:**  
DS-2DE5220IW-AE









DS-2DE5220IW-AE	
<b>Camera Module</b>	
Image Sensor	1/2.8" Progressive Scan CMOS
Minimum Illumination	Color: 0.02 lux @(F1.5, AGC ON) B/W: 0.002 lux @(F1.5, AGC ON); 0 lux with IR
White Balance	Auto / manual / ATW (Auto Tracking White Balance) / indoor / outdoor / fluorescent lamp / sodium lamp
AGC	Auto / manual
Shutter Speed	1 / 1 s to 1 / 30,000 s
Day & Night	IR cut filter
Digital Zoom	16x
Privacy Mask	8 programmable privacy masks
Focus Mode	Auto / semi-automatic / manual
3D DNR	Yes
BLC	Yes
Digital WDR	92 dB
HLC	Yes
Defog	Yes
<b>Lens</b>	
Focal Length	4.7 mm to 94 mm, 20x Optical
Zoom Speed	Approximately 3 s (optical lens, wide-tele)
Angle of View	58.3° to 3.2° (wide-tele)
Minimum Working Distance	10 mm to 1000 mm (wide-tele)
Aperture Range	F1.6 to F3.5
<b>Infrared</b>	
IR Distance	Up to 492 ft (150 m)
IR Intensity	Automatically adjusted, depending on the zoom ratio
<b>PTZ</b>	
Movement Range (Pan)	360° endless
Pan Speed	Configurable, from 0.1°/s to 160°/s, preset speed: 240°/s
Movement Range (Tilt)	From -15° to 90°
Tilt Speed	Configurable, from 0.1°/s to 120°/s, preset speed: 200°/s
Presets	300
Patrol Scan	8 patrols, up to 32 presets for each patrol
Pattern Scan	4 pattern scans, record time over 10 minutes for each scan
Park Action	Preset / pattern scan / patrol scan / auto scan / tilt scan / random scan / frame scan / panorama scan
Scheduled Task	Auto scan / frame scan / random scan / patrol / pattern / preset / panorama scan / tilt scan / dome reboot / dome adjust / aux output
<b>Features</b>	
Smart Detection	Intrusion detection, line crossing detection
ROI encoding	Main stream, sub-stream and third stream respectively support two fixed areas
<b>Network</b>	
Maximum Resolution	1920 × 1080
Main Stream	50 Hz: 25 fps (1920 × 1080, 1280 × 960, 1280 × 720); 50 fps (1280 × 960, 1280 × 720); 60 Hz: 30 fps (1920 × 1080, 1280 × 960, 1280 × 720); 60 fps (1280 × 960, 1280 × 720)
Sub-Stream	50 Hz: 25 fps (704 × 576, 640 × 480, 352 × 288); 60 Hz: 30 fps (704 × 480, 640 × 480, 352 × 240)
Third Stream	50 Hz: 25 fps (1920 × 1080, 1280 × 960, 1280 × 720, 704 × 576, 640 × 480, 352 × 288); 60 Hz: 30 fps (1920 × 1080, 1280 × 960, 1280 × 720, 704 × 480, 640 × 480, 352 × 240)
Video Compression	Main Stream: H.265+ / H.265 / H.264+ / H.264; Sub-Stream: H.265 / H.264 / MJPEG; Third Stream: H.265 / H.264 / MJPEG; H.264 with Baseline / Main / High Profile
Audio compression	G.711ulaw / G.711alaw / G.722 / G.726 / MP2L2 / PCM
Protocols	IPv4/IPv6, HTTP, HTTPS, 802.1x, Qos, FTP, SMTP, UPnP, SNMP, DNS, DDNS, NTP, RTSP, RTCP, RTP, TCP/IP, DHCP, PPPoE, Bonjour
Simultaneous Live View	Up to 20 channels
User / Host	Up to 32 users; 3 levels: Administrator, Operator and User
Security Measures	User authentication (ID and PW), Host authentication (MAC address); HTTPS encryption; IEEE 802.1x port-based network access control; IP address filtering
<b>System Integration</b>	
Alarm Input	2-ch alarm input
Alarm Output	1-ch alarm output
Alarm Linkage	Preset, patrol scan, pattern scan, memory card video recording, trigger recording, E-map, VCA capture, upload to ftp, send email, etc.
Audio Input	1-ch audio input
Audio Output	1-ch audio output
RS-485	Half duplex, HIKVISION, Pelco-P, Pelco-D, self-adaptive
CVBS	1.0V[p-p]/75 Ω, NTSC (or PAL) composite, BNC
Network Interface	1 RJ45 10 M/100 M ethernet interface
Storage	Built-in memory card slot, support microSD / SDHC / SDXC, up to 128 GB, NAS (NPS, SMB/ CIFS), ANR
API	Open-ended, supports ONVIF, PSIA and CGI, supports HIKVISION SDK and third-party management platforms

Client iVMS-4200, iVMS-4500, iVMS-5200  
 Web Browser IE 8+, Chrome 31+, Firefox 30+, Safari 8.0+ web browser

**General**

Power 24 VAC and Hi-PoE, maximum: 32 W  
 Working Temperature -22° F to 149° F (-30° C to 65° C)  
 Working Humidity ≤ 90%  
 Protection Level IP66 Standard, TVS 4000 V Lightning Protection, Surge Protection and Voltage Transient Protection  
 Dimensions Ø 7.28" × 12.99" (Ø 185 mm × 330 mm)  
 Weight Approximately 8.82 lbs. (4 kg)

**Accessories**

									
<b>WMP-L</b> Long Wall Mount	<b>CMP</b> Large Corner Mount for WMP-S/L	<b>PMP</b> Pole Mount for WMP-S/L	<b>JBPW-L</b> Power Box Mount w/Wall Bracket	<b>PMPL</b> Large Pole Mount for JBPW-L	<b>CMPL</b> Large Corner Mount for JBPW-L	<b>CPM-S</b> Short Ceiling Pendant Mount	<b>CPM-L</b> Long Ceiling Pendant Mount	<b>CPMPE</b> Ceiling Pendant Mount Extension Pipe	<b>RPM</b> Roof Parapet Mount

**Dimensions**

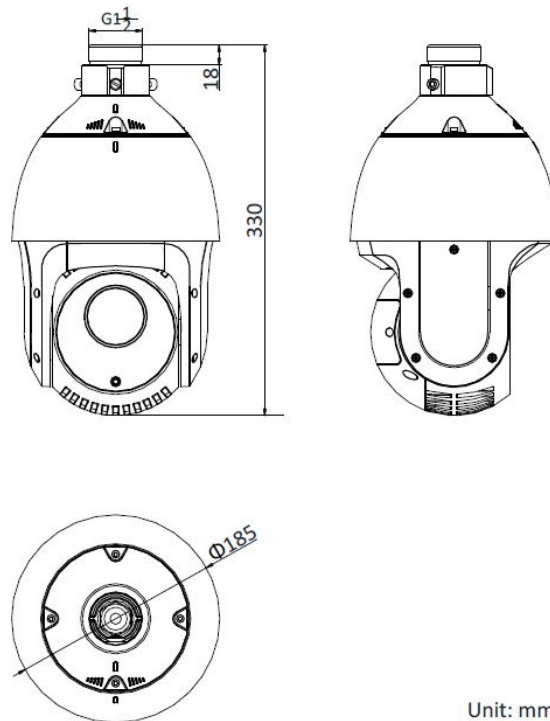

Unit: mm